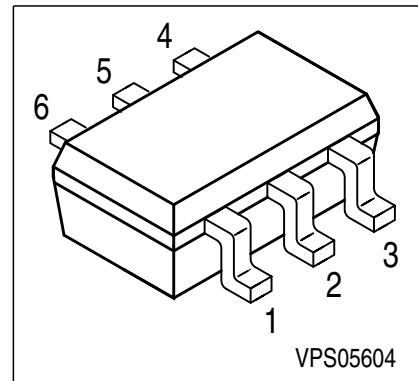
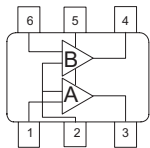
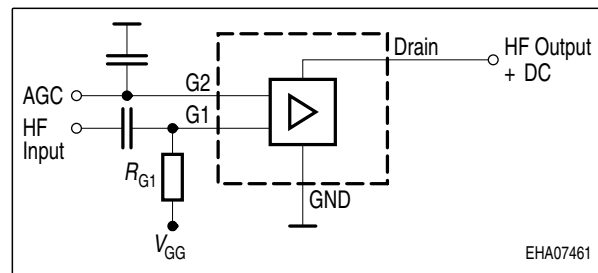
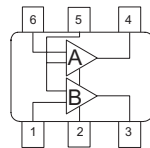

**DUAL N-Channel MOSFET Tetrode**

- Two gain controlled input stage for UHF and VHF -tuners e.g. (NTSC, PAL)
- Two AGC amplifiers in one single package
- Integrated gate protection diodes
- High AGC-range, low noise figure, high gain
- Improved cross modulation at gain reduction

**BG3130**

**BG3130R**

**ESD:** Electrostatic discharge sensitive device, observe handling precaution!

Type	Package	Pin Configuration						Marking
BG3130	SOT363	1=G1	2=G2	3=D	4=D	5=S	6=G1	KAs
BG3130R	SOT363	1=G1	2=S	3=D	4=D	5=G2	6=G1	KHs

180° rotated tape loading orientation available

**Maximum Ratings**

Parameter	Symbol	Value	Unit
Drain-source voltage	$V_{DS}$	8	V
Continuous drain current	$I_D$	25	mA
Gate 1/ gate 2-source current	$\pm I_{G1/2SM}$	1	
Gate 1/ gate 2-source voltage	$\pm V_{G1/G2S}$	6	V
Total power dissipation	$P_{tot}$	200	mW
Storage temperature	$T_{stg}$	-55 ... 150	°C
Channel temperature	$T_{ch}$	150	

**Thermal Resistance**

Parameter	Symbol	Value	Unit
Channel - soldering point <sup>1)</sup>	$R_{thchs}$	≤ 280	K/W

<sup>1)</sup>For calculation of  $R_{thJA}$  please refer to Application Note Thermal Resistance

**Electrical Characteristics**

Parameter	Symbol	Values			Unit
		min.	typ.	max.	
<b>DC Characteristics</b>					
Drain-source breakdown voltage $I_D = 10 \mu\text{A}$ , $V_{G1S} = 0 \text{ V}$ , $V_{G2S} = 0 \text{ V}$	$V_{(BR)DS}$	12	-	-	V
Gate1-source breakdown voltage $+I_{G1S} = 10 \text{ mA}$ , $V_{G2S} = 0 \text{ V}$ , $V_{DS} = 0 \text{ V}$	$+V_{(BR)G1SS}$	6	-	15	
Gate2-source breakdown voltage $+I_{G2S} = 10 \text{ mA}$ , $V_{G1S} = 0 \text{ V}$ , $V_{DS} = 0 \text{ V}$	$+V_{(BR)G2SS}$	6	-	15	
Gate1-source leakage current $V_{G1S} = 6 \text{ V}$ , $V_{G2S} = 0 \text{ V}$	$+I_{G1SS}$	-	-	50	$\mu\text{A}$
Gate2-source leakage current $V_{G2S} = 8 \text{ V}$ , $V_{G1S} = 0 \text{ V}$ , $V_{DS} = 0 \text{ V}$	$+I_{G2SS}$	-	-	50	nA
Drain current $V_{DS} = 5 \text{ V}$ , $V_{G1S} = 0 \text{ V}$ , $V_{G2S} = 4.5 \text{ V}$	$I_{DSS}$	-	-	10	$\mu\text{A}$
Drain-source current $V_{DS} = 5 \text{ V}$ , $V_{G2S} = 4 \text{ V}$ , $R_{G1} = 120 \text{ k}\Omega$	$I_{DSX}$	-	10	-	mA
Gate1-source pinch-off voltage $V_{DS} = 5 \text{ V}$ , $V_{G2S} = 4 \text{ V}$ , $I_D = 20 \mu\text{A}$	$V_{G1S(p)}$	-	0.7	-	V
Gate2-source pinch-off voltage $V_{DS} = 5 \text{ V}$ , $I_D = 20 \mu\text{A}$	$V_{G2S(p)}$	-	0.6	-	

**Electrical Characteristics**

Parameter	Symbol	Values			Unit
		min.	typ.	max.	
<b>AC Characteristics</b> $V_{DS} = 5V$ , $V_{G2S} = 4V$ , ( $I_D = 14$ mA) (verified by random sampling)					
Forward transconductance	$g_{fs}$	-	33	-	mS
Gate1 input capacitance $f = 10$ MHz	$C_{g1ss}$	-	1.9	-	pF
Output capacitance $f = 10$ MHz	$C_{dss}$	-	1.1	-	
Power gain $f = 800$ MHz $f = 45$ MHz	$G_p$	- -	24 31	- -	dB
Noise figure $f = 800$ MHz $f = 45$ MHz	$F$	- -	1.3 1.7	- -	
Gain control range $V_{G2S} = 4 \dots 0$ V, $f = 800$ MHz	$\Delta G_p$	45	-	-	
Cross-modulation $k=1\%$ , $f_w=50$ MHz, $f_{unw}=60$ MHz AGC = 0 dB AGC = 10 dB AGC = 40 dB	$X_{mod}$	90 - 96	- 87 100	- - -	-

**Total power dissipation  $P_{tot} = f(T_S)$**

amp. A = amp. B

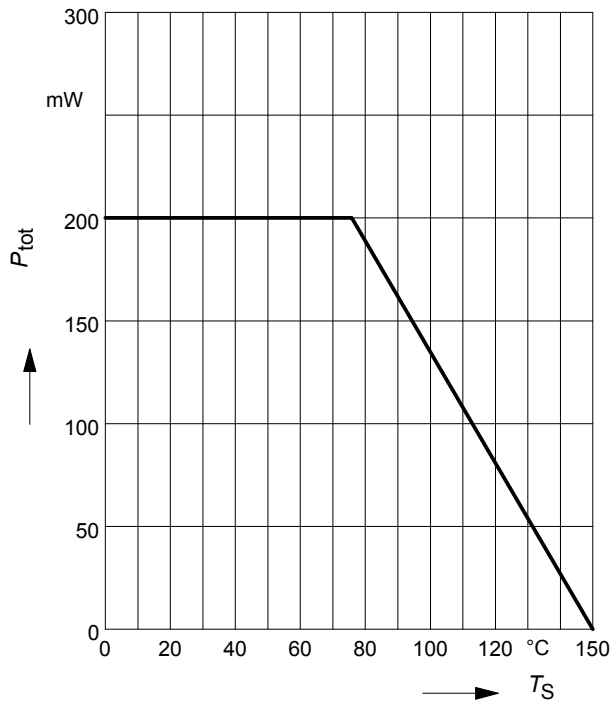

**Drain current  $I_D = f(I_{G1})$**

$V_{G2S} = 4V$

amp. A = amp. B

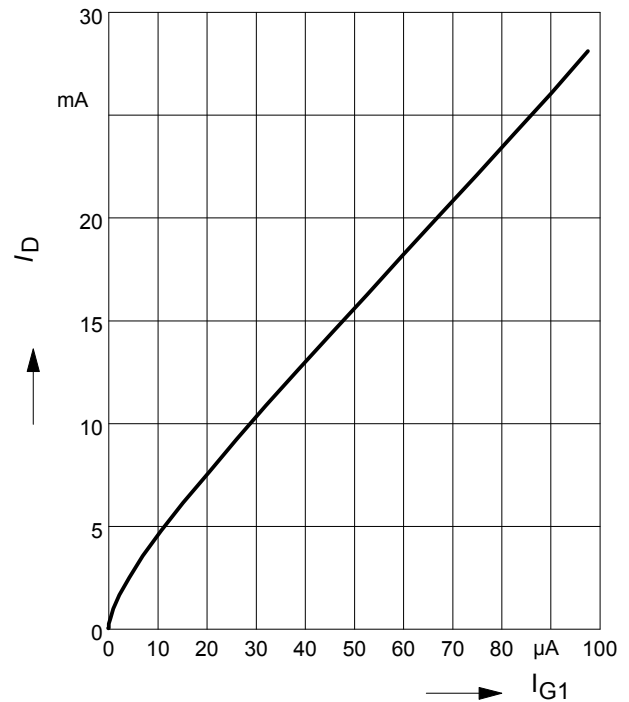

**Output characteristics  $I_D = f(V_{DS})$**

amp. A = amp. B

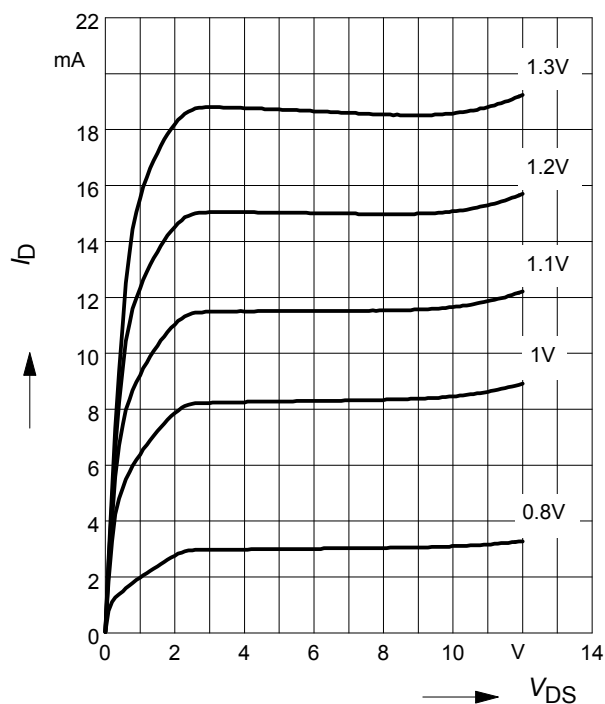

**Gate 1 current  $I_{G1} = f(V_{G1S})$**

$V_{DS} = 5V, V_{G2S} = \text{Parameter}$

amp. A = amp. B

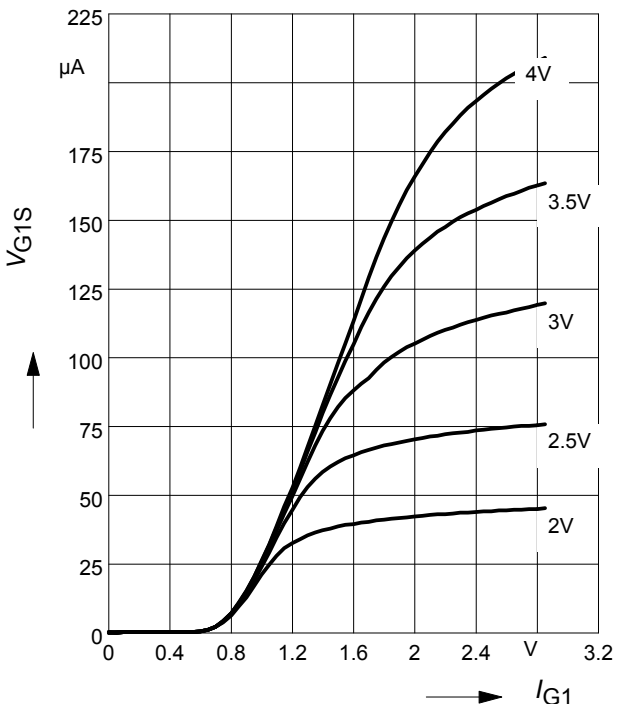

**Gate 1 forward transconductance**

$g_{fs} = f(I_D)$ ,  $V_{DS} = 5V$ ,  $V_{G2S} = \text{Parameter}$   
 amp. A = amp. B

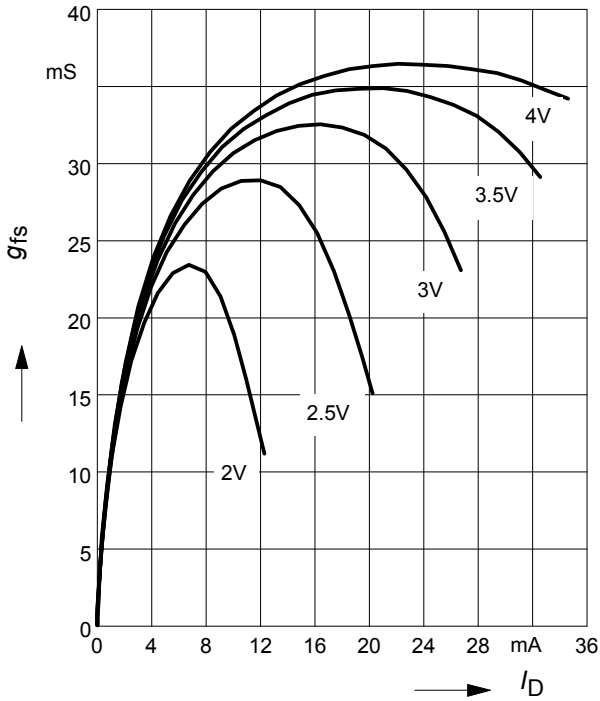

**Drain current  $I_D = f(V_{G1S})$**

$V_{DS} = 5V$ ,  $V_{G2S} = \text{Parameter}$   
 amp. A = amp. B

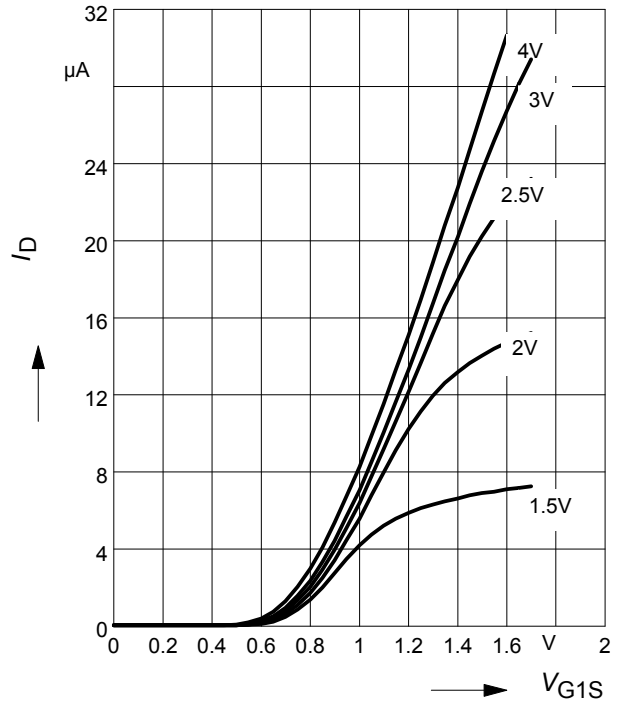

**Drain current  $I_D = f(V_{GG})$  amp.A=amp.B**

$V_{DS} = 5V$ ,  $V_{G2S} = 4V$ ,  $R_{G1} = 120k\Omega$   
 (connected to  $V_{GG}$ ,  $V_{GG} = \text{gate1 supply voltage}$ )

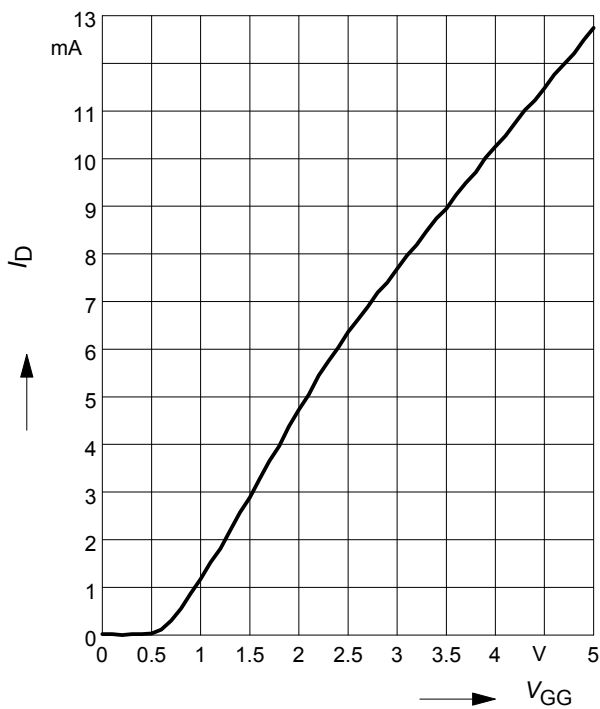

**Drain current  $I_D = f(V_{GG})$**

$V_{G2S} = 4V$ ,  $R_{G1} = \text{Parameter in } k\Omega$   
 amp. A = amp. B

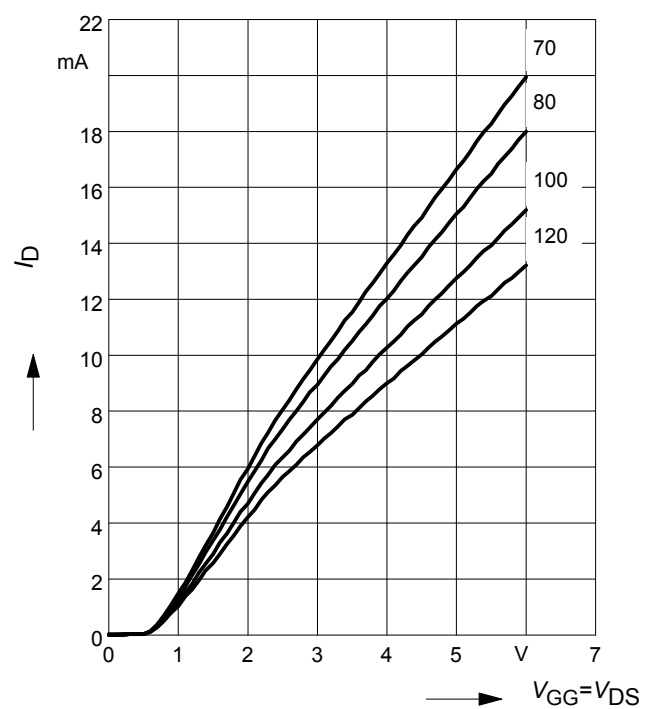

**Crossmodulation  $V_{unw} = (AGC)$**

$V_{DS} = 5\text{ V}$ ,  $R_{g1} = 68\text{ k}\Omega$

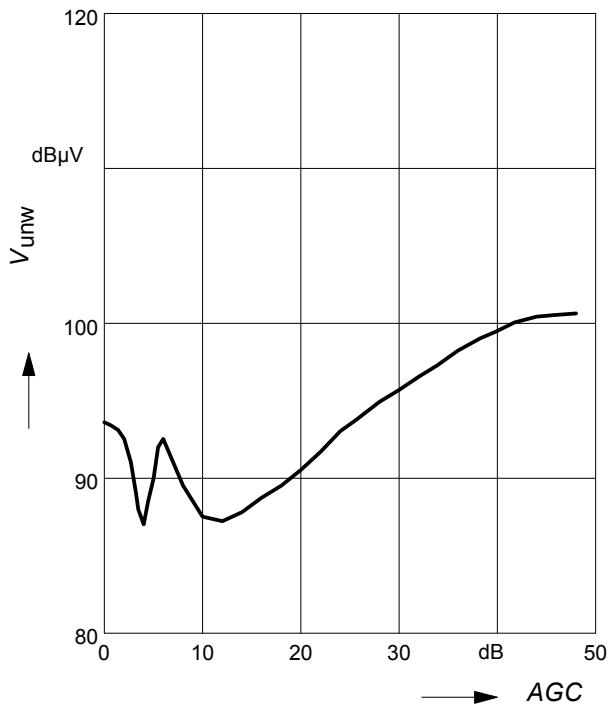

**Crossmodulation test circuit**

